

Georgia Institute of Technology  
Environmental Health and Safety

# HAZARDOUS WASTE PROCEDURES

May 2011



<http://www.ehs.gatech.edu>

## TABLE OF CONTENTS

---

<b>Table of Contents</b> .....	<b>1</b>
<b>Overview of Waste Management Procedures</b> .....	<b>3</b>
Introduction.....	3
EHS contact information .....	3
<b>1. General Instructions and Purpose</b> .....	<b>4</b>
1.1 Definitions.....	4
1.2 General waste management procedures and waste determination process .....	5
Material for which EHS is responsible: .....	6
Material for which EHS is NOT responsible: .....	6
1.3 Types of waste.....	7
1.4 Waste minimization .....	8
<b>2. Chemical Waste Procedures</b> .....	<b>10</b>
2.1. Container management, provisions, and selection.....	10
2.2 Container labeling.....	11
2.3 Waste accumulation areas .....	12
2.4 removal of waste.....	14
2.5 Management practices .....	14
Segregation of incompatible wastes.....	14
Waste accumulation.....	16
Unidentified wastes.....	16
2.6 Training .....	17
<b>3. Biological Waste Procedures</b> .....	<b>18</b>
3.1 Container packaging and labeling.....	18
3.2 Accumulation .....	19
3.3 Collection.....	19
3.4 Transport.....	19
3.5 Training .....	20
<b>4. Waste Management Procedures for Used OIL, Oil Filters, and Oil and Solvent Laden Rags</b>	<b>21</b>
4.1 Management of used oil containers .....	21
4.2 Labeling .....	21
4.3 Segregation.....	21
4.4 Collection.....	21
4.5 Used oil filters .....	21
4.6 Oil and solvent laden rags.....	21
4.7 Training .....	22
<b>5. Waste Management Procedures – Used Fluorescent Lamps and Lighting Ballasts</b> .....	<b>23</b>
5.1 Management of used mercury containing lamps.....	23
Containers .....	23
Labeling.....	23

Segregation ..... 23

Collection ..... 23

5.2 Management of ballasts ..... 23

    Labeling..... 24

    Segregation ..... 24

    Collection ..... 24

5.3 training..... 24

**6. Waste Management Procedures – Used Batteries..... 26**

    6.1 Management of Batteries..... 26

    6.2. Battery Safety..... 26

    6.3. Labeling ..... 27

    6.4 Segregation ..... 27

    6.5 Collection..... 27

    6.6 Training ..... 27

**7. Hazardous Waste Management Procedures – Spills/Incidents..... 28**

**8. Waste Management Procedures – Aerosol Cans ..... 29**

    8.1 Which aerosol cans are regulated as chemical waste? ..... 29

    8.2 Which aerosol cans are not regulated as chemical waste? ..... 29

    8.3 Puncturing aerosol cans..... 29

**9. Waste Management Procedures – Drain and Trash Disposal of Material By Users ..... 30**

**10. Refrigerants (Ozone Depleting Substances) ..... 33**

**11. Self-Transport of Hazardous Materials ..... 34**

**Appendix A Highly Hazardous Chemicals List ..... 36**

**Appendix B Laboratory Configurations..... 43**

## OVERVIEW OF WASTE MANAGEMENT PROCEDURES

---

### INTRODUCTION

The following procedures have been established by Georgia Tech's Environmental Health and Safety Office (EHS) for the management and disposal of:

- Chemical waste
- Biological/infectious waste
- Used fluorescent lamps and ballasts
- Used batteries
- Used oil and oil filters
- Radioactive materials (procedures published separately by the Office of Radiological Safety (ORS))

In addition, procedures have been developed for the following special topics, which may also be referenced in the above procedures:

- Spill/Incident procedures.
- Drain and trash disposal of materials by users
- Aerosol cans
- Handling of Ozone Depleting Substances
- Self-Transport of Hazardous Materials

### EHS CONTACT INFORMATION

- EHS Main Office
  - » 490 10<sup>th</sup> Street, 3<sup>rd</sup> Floor, Suite 313
  - » (404) 894-4635
- EHS Office website: [www.ehs.gatech.edu](http://www.ehs.gatech.edu)
- Ed Pozniak – Hazardous Materials Manager – 404-894-6224; [edward.pozniak@ehs.gatech.edu](mailto:edward.pozniak@ehs.gatech.edu)
- Brian Clemons – Hazardous Materials Specialist II – 404-894-0499; [brian.clemons@ehs.gatech.edu](mailto:brian.clemons@ehs.gatech.edu)
- Therrell Hall – Hazardous Materials Specialist II – 404-894-9258; [therrell.hall@ehs.gatech.edu](mailto:therrell.hall@ehs.gatech.edu)

ALWAYS contact EHS if there is ANY uncertainty about the appropriate management of a waste.

## 1. GENERAL INSTRUCTIONS AND PURPOSE

---

This document establishes procedures to manage waste streams generated at Georgia Institute of Technology. These procedures are applicable to all Georgia Tech faculty, staff, and students, and include affiliated operating units such as the Georgia Tech Research Institute (GTRI), the Advanced Technology Development Center (ATDC), Auxiliary Services, and the Athletic Association. The purpose of this document is to present procedures to be followed to comply with the federal [United States Environmental Protection Agency (USEPA) and state [Georgia Environmental Protection Division (GAEPD)] regulations, to minimize long term liability, and to act as good environmental stewards.

### 1.1 DEFINITIONS

Definitions as used in these procedures are provided below. Additional definitions are provided within specific procedures.

*Hazardous waste* means any material no longer of use to the possessor whose chemical or biological properties have the potential to endanger personnel, material, or the environment if handled improperly. Hazardous waste includes, but is not limited to items specifically identified as “hazardous waste” under federal and state statutes.

*Chemical waste* means a waste that may be potentially harmful to people, equipment or the environment, typically based on information provided in Material Safety Data Sheets (MSDSs), chemical information databases, or through consultation with a supervisor such as a Principal Investigator (PI), Research Scientist, or Facilities Operations and Maintenance Area Manager.

*Biological waste* means any waste material whose biological properties present (or may be conceived to present) a risk or potential risk to the health of humans, or plant or animal life, either directly through infection or indirectly through damage to the environment. It includes but is not necessarily limited to:

- » Human, mammal, and plant pathogens (bacteria, parasites, fungi, viruses)
- » All human blood, blood products, tissues, and certain body fluids, including used, absorbent materials contaminated with blood, blood products, or other potentially infectious material, and non-absorbent, disposable devices that have been contaminated with blood, body fluids, or other potentially infectious materials.
- » Cultured human or mammalian cells and potentially infectious agents these cells may contain
- » Clinical specimens
- » Infected mammals and mammalian tissues.

*Sharps* include any item that can lacerate or puncture the skin. Examples include:

- » Hypodermic needles
- » Syringes (with or without the needle attached)
- » Broken pipettes (unbroken pipettes will be regarded as sharps if they contain biological, chemical or infectious agents)
- » Scalpel blades
- » Knives
- » Box cutters
- » Razor blades

*Used oil* means any oil that has been refined from crude oil, or any synthetic oil, that has been used, and as a result of such use is contaminated by physical or chemical impurities. Examples of used oil include motor oil, hydraulic fluid, lubricants and oil coolants.

*Unidentified waste* means a waste of unknown constituents or origin. For the purposes of these procedures, unidentified wastes are managed as hazardous wastes until a definitive determination can be made by EHS.

## **1.2 GENERAL WASTE MANAGEMENT PROCEDURES AND WASTE DETERMINATION PROCESS**

Federal, state, and local governments impose strict regulations concerning the management, storage, and disposal of hazardous materials. Compliance with these laws, good safety practices, and the necessity to avoid liabilities dictate that Georgia Tech take a conservative approach in handling this material.

The Office of Radiological Safety (ORS), has a separate published radiation safety policy (<http://www.org.gatech.edu/rsm.pdf>) and procedures (<http://www.ors.gatech.edu/Procedures/>) for the accountability, management and disposal of radiological materials.

Within specific activities, EHS will provide advice and technical assistance regarding hazardous wastes. However, it is the responsibility of each individual to know the possible dangers associated with any material being used or generated, and know how the material should be handled and disposed of **BEFORE A PROJECT BEGINS.**

EHS provides pick up of hazardous materials. Georgia Tech faculty, staff and students will not arrange for off or on site disposal of hazardous material or use Georgia Tech's USEPA ID number(s) without prior coordination with EHS. This does not preclude the routine transfer of chemicals between on campus work areas or the use of the ID number on research proposals.

Material for which EHS is responsible:

- Chemical waste, as described above
- “Highly Toxic Material,” which is a chemical which is either specifically identified by the USEPA as a “highly hazardous chemical” or has a Lethal Dose 50 (LD<sub>50</sub>) of 50 mg/kg or less (oral-rat). Examples include inorganic cyanides, pesticides, and arsenic compounds. A listing of USEPA listed “highly hazardous chemicals” is at Attachment A to these procedures.
- Used oil
- Biological/infectious waste
- Fluorescent bulbs and ballasts
- Batteries
- Asbestos
- Lead-based paint, as well as material coated with lead-based paint
- Radiological waste (separate procedures)

**Material for which EHS is NOT responsible:**

- Broken glass, whose only danger comes from its ability to inflict wounds, is not considered hazardous waste. Activities which anticipate generating broken glass should obtain puncture proof containers and dispose of the material appropriately.
- Electronic waste, which includes unwanted computers, monitors, televisions, audio equipment, printers, laptops, fax machines, telephones, and other electronic equipment. When electronic equipment breaks or becomes obsolete, it must be properly disposed of or recycled. This equipment may contain heavy metals and other materials that may be hazardous to human health and the environment and, hence, cannot be disposed of as normal trash. Do not place any electronic equipment in the trash, even if it is broken. When these items are replaced or otherwise no longer needed, they need to be disposed of properly. At Georgia Tech all such items, whether or not they carry a Georgia Tech Inventory number, are to be processed through Property Control. Specific procedures can be found at <http://www.procurement.gatech.edu/howdoisurplus.php>.
- Appliances (refrigerators) or equipment containing "freon" or "freon mixtures" destined for salvage or surplus. If coolant requires removal, contact the appropriate maintenance zone for the assistance or a qualified technician.

### 1.3 TYPES OF WASTE

At Georgia Tech, wastes are generated in two primary areas: academic settings (such as laboratories), and facility operations (such as maintenance operations). For the purposes of this procedure, Georgia Tech faculty, staff, and students will identify a waste material using the following decision tree:

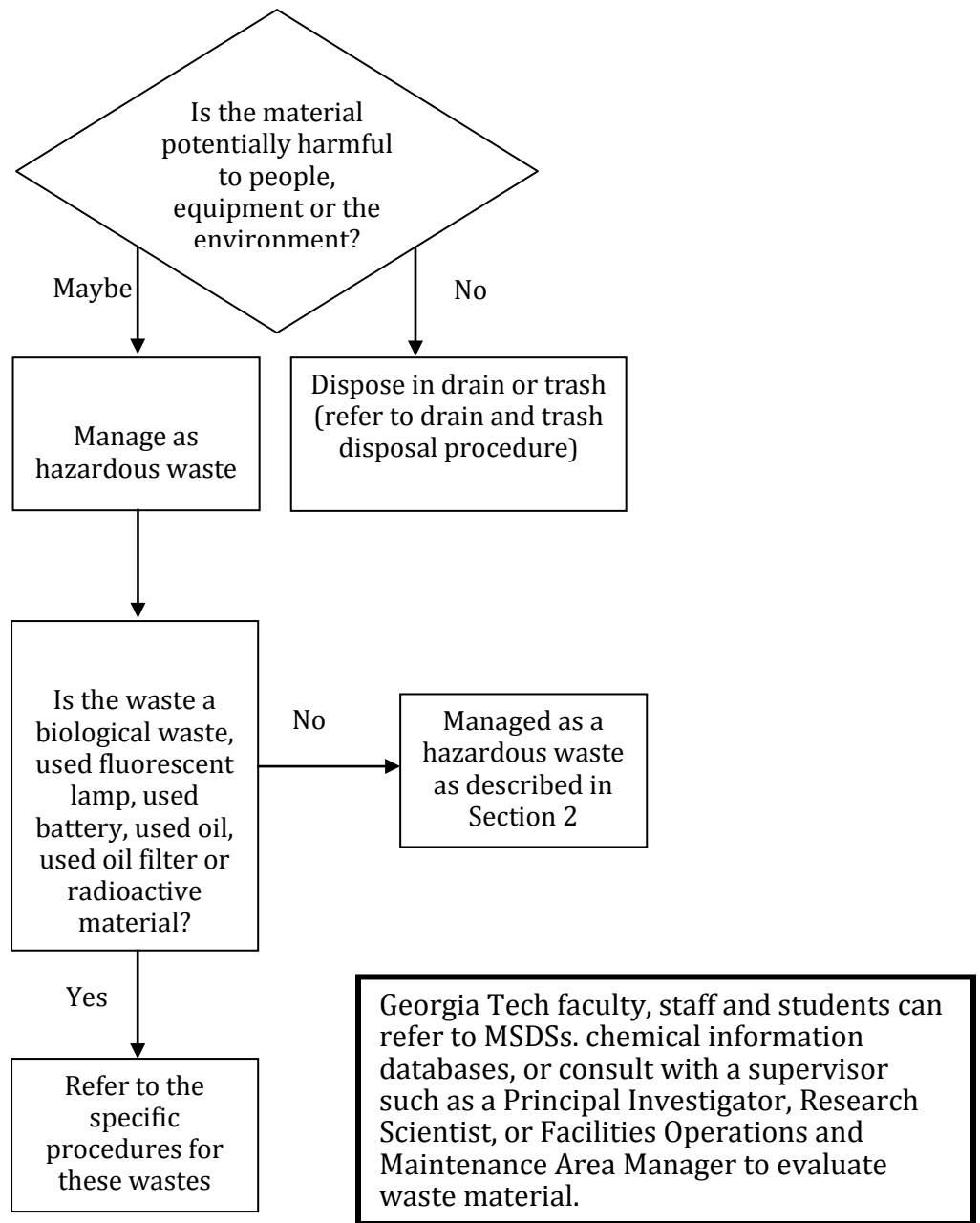



## 1.4 WASTE MINIMIZATION

Environmental regulations and Georgia Tech fiscal responsibilities require that as little hazardous waste as possible be generated. Good purchasing decisions are the first steps in minimizing waste generation. Every effort must be made to keep purchase quantities to a minimum. Remember "LESS IS BEST" when planning work and ordering chemicals. Stockpiling products for future use or to take advantage of unit cost savings doesn't work. This is because any net savings in purchase are lost during disposal if the chemical is not completely used. The average cost to dispose of unused hazardous materials may be two to three times the original purchase cost. Purchase only the quantity of material that will be completely used within a reasonable time frame. Unnecessary stockpiling of chemicals also uses valuable space that is often at a premium in laboratories and other facilities.

- Limit the amount you order. Review chemical stocks and needs before ordering.
- Do not stockpile chemicals.
- Avoid duplication - Check your inventory to avoid ordering chemicals that are already in stock. Keep up to date inventories.
- Rotate chemical stocks to use up chemicals before their shelf lives expire. This impacts research and may impact the credibility of results: some chemicals, both organic and inorganic, may degrade or otherwise have reduced or modified reactions over time.
- Be wary of offers of "free" research materials or chemicals from outside Georgia Tech. All too often "freebies" are inadequately labeled, or are packaged in large, industrial quantities that will not be used up. Research scale quantities, complete labels and material safety data sheets are required for any free materials.

The following guidelines are a checklist to accomplish waste minimization – they are not intended to restrict activities:

- Before beginning a project, determine the hazards associated with the material. Where possible substitute less hazardous substances.
- Use small batch or micro-level reactions where possible.
- Order and maintain minimum quantities of chemicals.

- Certain chemicals are difficult and/or costly to dispose of and should be given special consideration. Some types are:
  - 1) Heavy metals, *e.g.*, mercury, barium, cadmium, chromium, beryllium, silver, selenium, tellurium, either elemental or in compounds.
  - 2) Chlorophenols, dioxins, and cyanides.
  - 3) Compressed gases (to include lecture bottles) or containers with liquids under pressure (especially if the substance is poisonous). Where possible arrange with the supplier to accept return of used containers.
  - 4) Manufacturers' samples. Either arrange for the manufacturer to accept return of unused material or ensure they provide an ample description of the product and its characteristics. Contact EHS for help with preparing or making this request.

## 2. CHEMICAL WASTE PROCEDURES

---

The following provides specific procedures for managing chemical wastes generated at Georgia Tech.

### 2.1. CONTAINER MANAGEMENT, PROVISIONS, AND SELECTION

It is the responsibility of the generating activity to provide suitable waste containers for waste accumulation. A container that is bulging, severely dented, rusted, cracked, or leaking would not be considered a container in good condition. Waste containers must be compatible with the waste collected, kept closed unless material is being added, capable of being transported, and appropriately labeled. Do not use containers over 5 gallons/20 liters without prior consultation with EHS.

Multiple small containers, such as sample vials containing research products, should be consolidated into single packages.

Consider keeping a log to record the date, amount and type of waste added to a container to prevent the mixing of incompatibles.

EHS cannot guarantee that re-useable containers will be returned to the waste generator. EHS makes a good faith effort to return containers whose contents can be combined with other wastes. In general, EHS does not supply containers. If needed, please contact EHS for recommendations about obtaining a new container.

Below are recommended best practices regarding the use and storage of containers. Additional required practices are specified within this procedure.

- 1) Do not fill liquid containers completely full. As a rule of thumb, the volume in a container should be limited to no more than 95% of the total capacity of a container.
- 2) **Keep containers closed** except when adding material to the container. This is to prevent spills, leaks, fires and exposure to fumes.
  - › Open head drums should be closed with a ring and bolt securing the lid to the container. If present, bung hole opening are closed.
  - › Smaller containers should be closed with a closed screw top lid.
- 3) A funnel may help prevent spills when adding waste to containers; make sure it is clean and free of residues. Flip-top funnels alleviate the necessity to remove the funnel and replace container caps after each use and, hence, are highly recommended. If you must leave a funnel in place, it must be maintained closed when not adding material to the container, and it must contain either a locking mechanism

for the lid, or include or a gasket in the lid, to make it spill and vapor proof.

- 4) Containers must be made of, or lined with, materials that are compatible with, and will not react with, the waste to be stored in the container. For example, a corrosive waste such as nitric acid is incompatible with a steel container because the acid reacts with the steel.
- 5) EHS does not recommend “red metal safety cans” for the storage of liquid wastes. These metal cans do not meet USDOT standards for transport and the spark arrestors with the cans corrode and become ineffective over time. It is also difficult to pour from metal cans into a bulk drum, which increases the risk of a spill.
- 6) Consult MSDS to identify the appropriate personal protective equipment (goggles, face shield, gloves and lab coat or similar protective outer garment) required when adding waste to containers. Please contact EHS with questions about personal protective equipment.
- 7) Keep containers in good condition, handle them carefully, replace leaking ones immediately, and keep the outside is clean.
- 8) Segregate waste containers according to chemical compatibility just as you would unused chemicals - flammables, oxidizers, reactives, corrosive acids and bases must be stored separately.
- 9) Do not store usable chemicals, reagents or unmarked bottles with waste containers. These may be mistaken for improperly labeled waste.
- 10) EHS strongly recommends the use of secondary containment for liquid waste. Secondary containment may be a tray, pan, bucket or other container capable of holding the entire contents of the primary container in the event of a leak or spill. Secondary containment aids in separating incompatible waste and in cleanup of leaks and spills. Please contact EHS with questions regarding secondary containment options for containers.

## **2.2 CONTAINER LABELING**

The preferred method of generating hazardous waste labels is through CHEMTAIX. When possible, activities should utilize CHEMTAIX generated "waste cards." In the event that CHEMTAIX is not available to an activity, it may use their own label or it can contact EHS to obtain a label. Container labels must be compatible with the waste type. Some inks and markers may run or become illegible on contact with some solvents. Some adhesive labels may fall off or be damaged on contact with solvents, acids or bases.

Waste collection containers must be clearly labeled with the following:

- 1) The type of waste being accumulated in the container, *e.g.*, "halogenated solvent, hydrochloric acid." **Generic terms that give no indication of the type hazard associated with the waste, e.g., "aqueous waste", are not acceptable, nor is a chemical formula.**
- 2) Approximate amount or percentage of each constituent.

**Before** the material is picked-up the following must be on the label:

- The name and telephone number of an individual who certifies the waste container contents.
- The actual contents of the container – provide chemical names, not abbreviations or chemical formulas.

Containers of excess materials, with the manufacturers' original label, need not be re-labeled, unless, the manufacturers' label does not identify the contents by chemical name. In such case the activity must appropriately label the container or provide a MSDS for the material.

In the event that a product name, rather than constituent information, is provided on a label, provide a MSDS for that product to EHS at the time of pickup.

Address any questions to EHS.

### **2.3 WASTE ACCUMULATION AREAS**

Regulations place significant requirements and restrictions on the management of chemical waste. These requirements are somewhat relaxed provided waste in a given area does not exceed 55 gallons and is at or near the point of generation and under control of the operator. There are various interpretations of the terms "at or near" and "under the control of." At Georgia Tech, the working definition of such areas is "connected, contiguous space under the control of a single operating unit", where an operating unit is a PI or a geographically contained space with a specific function, such as a clean room. Generally, waste may not be transported along or across areas (such as hallways) accessible to the general population. There are several examples of what is and is not allowed at Georgia Tech **click on the appropriate descriptions, below for graphic examples.** Operational units which have a high potential for accumulating over 55 gallons of waste or which must move waste through public areas must consult with EHS, to either modify procedures or establish a "90 Day Accumulation Area" which will place an additional training and administrative burden on the operating unit.

- Single Lab, One Primary Investigator
- Contiguous, connected labs with a single Primary Investigator
- Contiguous, connected lab, each with own Primary Investigator
- Contiguous, connected labs, two (or more) Primary Investigators run a joint lab.
- Contiguous, but not connected labs, single Primary Investigator.
- Contiguous, connected labs with interstitial space, one Primary Investigator.
- Contiguous, connected labs with interstitial space, multiple Primary Investigators.
- Open Lab, single Primary Investigator
- Open Lab, Multiple Primary Investigators.
- Sub-Divided, open lab.
- Maintenance Zones (or similar)
- Common use space, such as cold rooms, specialized instrument rooms etc.

Please contact EHS for situations that are not addressed by the above.

## 2.4 REMOVAL OF WASTE

EHS is responsible for picking up hazardous waste from individual activities. The preferred method to notify EHS of a need for a pick up is through Georgia Tech's Chemical Inventory System (CHEMATIX) generated service orders. Activities which have transitioned to CHEMATIX are encouraged to use these procedures. CHEMATIX provides mechanisms for:

- Identifying and bar-coding containers of chemicals to include items generated in the workplace.
- Creating labels (called "waste cards") to include bar codes for waste containers.
- Requesting pick up of waste via the internet
- Automatic updating of inventories when the material is removed by Hazardous Material personnel.

Alternatively, contact EHS by phone or e-mail for a pick up. In most instances, EHS will respond to requests within three working days, If material is not removed within three working days and the requestor has not been contacted with a reason, please re-notify EHS.

For areas outside the Main Campus Area:

- 1) Cobb County Research Facility and GT Savannah: Contact the designated Hazardous Waste Point of Contact.
- 2) Other areas (14th Street IEC, North Avenue Research Area, and NEETRAC): Contact EHS. In most cases, material will not be removed from the original point of generation but EHS will arrange for a contractor to pick-up material direct from the facility.

## 2.5 MANAGEMENT PRACTICES

### Segregation of incompatible wastes

To the extent feasible, waste should be segregated and not combined. Segregation of chemical waste has several advantages: the prevention of unwanted or potentially dangerous reactions, the protection of laboratory and EHS personnel from potentially unsafe working environments, ease in handling and disposing of wastes the reduction of disposal costs. Segregate solids, liquids, and gases. Further segregation can be by hazard class. Hazard class examples include, but are not limited to: flammable, oxidizer, pyrophoric, reactive, reducer, acid, base, and toxic.

The following guidelines have been developed to assist in generating a well defined and separated waste stream.

- Collect inorganic substances separately and do not mix solids with liquids unless the generation of a process waste is involved.

- Flammable liquids and other organics must be segregated from acidic and caustic wastes.
- To the extent procedures allow do not mix or pack together:
  - » Acids with bases
  - » Flammable or combustibles with oxidizers
  - » Cyanides with other materials
  - » Flammable with non-flammable solvents
  - » Resins with the hardeners or catalysts
- Collect halogenated and non-halogenated organic solvents in different containers.
- Recycle vacuum pump oil and do not mix with organic solvents or other chemicals. If the pump oil is not mixed with solvents or other chemicals, manage it as used oil according to the procedures herein. If it is mixed with solvents or other chemicals, indicate on the label as "pump oil contaminated with other chemicals" and manage according to the procedures herein.
- Contact EHS for disposal of lab ware and equipment contaminated with highly hazardous chemicals (see Attachment A for a listing). This includes disposable laboratory items such as gloves, bench top coverings, pipettes, glassware, and aprons.
- Lab scraps not contaminated with hazardous materials can be disposed of in trash.
- Dispose of empty containers that were used for, or that are contaminated with, highly hazardous materials through EHS.
- Do not put empty glass chemical containers directly into normal trash.
  - 1) Rinse containers that held acids or bases with water and dispose of rinse water in a sink.
  - 2) Place empty solvent containers into a hood overnight to evaporate residual materials.
  - 3) The glass bottles can be disposed in a commercial dumpster. Leave containers uncapped and deface the label.



## **Waste accumulation**

As a best practice, excess amounts of waste and/or unneeded material are not to accumulate.

Waste generated in the process of conducting research or other activities (*e.g.*, spent solvents) will be removed on a routine basis. Except for those areas designated and managed as “90-day accumulation areas”, in no case will an activity allow more than 55 gallons (~200 kg) of waste (aggregate total, not per waste stream type) to accumulate [no more than 1 quart (~1 kg) of a highly hazardous chemical], nor will any waste container be retained for longer than 1 calendar year. Multiple containers of waste may be in one waste accumulation area; however, the total amount of waste storage in the containers cannot exceed 55 gallons.

At the end of any project or prior to the departure of an individual, all research products and other material (wastes and non-wastes) shall be clearly identified and disposed in accordance with these procedures and Georgia Tech’s laboratory procedure.

Each laboratory/activity will conduct at least a semiannual physical survey of their area and dispose of unneeded/expired material, ideally in conjunction with the Chematix semiannual reconciliation. Special attention will be given to the following:

- Flammable and other storage cabinets
- Refrigerators and freezers
- Ethers and other peroxide forming substances
- Materials that become more dangerous due to evaporation such as sodium, organo-metallic compounds in solvents, or picric acid
- Strong irritant chemicals such as beta-mercaptoethanol.

A responsible individual (*e.g.*, a PI or Shop Foreman) will review the semiannual inventory and attest to the fact that the materials retained are usable and needed. Records will be maintained of these reviews.

## **Unidentified wastes**

Unidentified wastes shall be managed as chemical wastes. If a source (*e.g.*, a laboratory or maintenance shop) has a container with unidentified contents, readily available information on the material should be gathered by the faculty, student, or staff member. This information may be helpful in reducing the number of steps needed to suitably classify the material. Identification of unknown materials can be an expensive, time consuming, and potentially dangerous process. The ultimate responsibility for this resides with EHS. Any information that can narrow the potential range of waste materials can be useful. Besides safety issues, costs for classifying even small amounts of unknown materials are significant. In many cases, personnel in a research group can, by process of elimination and knowledge of lab operations, provide valuable information on the chemical constituents.

Laboratories must manage unknown materials with great care. Containers encountered with unknown materials must not be moved or opened when there is any question as to the safety of such an operation. This is because some materials are friction or shock sensitive and even the act of opening the cap (*e.g.*, picric acid) can cause a violent reaction. The laboratory must be able to identify if a container potentially includes a highly reactive or explosive component prior to their or EHS's management of the container and its material.

EHS will make the final determination of whether a waste is a hazardous waste in accordance with its standard operating procedures. However, the laboratory staff must provide all available background information. Reasonable attempts to identify unknowns must be made by the laboratory personnel. If highly reactive materials cannot be ruled out, laboratory staff must not handle the material, and EHS will arrange for proper identification and disposal.

It is important to note: The best way to prevent the generation of unknown waste materials is to properly use, label, and manage all chemical materials and byproducts, including solutions and mixtures prepared on campus.

## **2.6 TRAINING**

All individuals whose duties include the identification, handling, and management of chemicals wastes shall participate in a training program prior to their initial involvement of such activities.

Georgia Tech EHS offers periodic classroom training sessions. Please contact EHS with questions regarding training needs. Alternatively, the Board of Regents website has a suitable awareness training program that can be accessed at <http://www.usg.edu/ehs/training/hazwaste/>. Two on-line training programs are under development: one for laboratory related activities and one for facilities and maintenance activities. Please select the training program that is appropriate for your job function.

### 3. BIOLOGICAL WASTE PROCEDURES

---

While EHS has the overall operational responsibility for the scheduling, coordination, documentation and day-to-day operations required to segregate, collect, transfer, process and dispose of biological wastes, such materials will only be handled by EHS when all proper safety procedures are implemented.

#### 3.1 CONTAINER PACKAGING AND LABELING

Biological wastes shall be segregated by separate containment from other waste at the point of generation. These wastes, except for sharps, are to be placed in orange or red plastic bags clearly identified with the universal biohazards symbol or the word "BIOHAZARD." The bags must be placed into a biohazard cardboard box and properly marked with the PI's (or other responsible party's) name. EHS supplies bags and boxes. For buildings with a high volume of biological waste, supplies will be provided at a central location; for isolated laboratories, supplies will be delivered to that location.

- Biological waste requiring special handling:
  - » Biological waste containing infectious or potentially infectious agents must be autoclaved before being boxed for disposal.
  - » Liquid biological materials which can be properly inactivated may be appropriately treated and disposed of as the normal sewage. See the Institute Bio-Safety Manual for treatment methods and Section 9 for drain disposal guidelines. Liquids which cannot be so treated must be placed in non-breakable (plastic) and tightly sealed containers before being boxed.
  - » Biological wastes which also have a significant chemical component (*e.g.*, phenol/chloroform or heavy metals) must have the biological component inactivated (usually by autoclave) and then disposed of as chemical waste.
  - » Material which is refrigerated or frozen requires special coordination and scheduling with EHS. The intent is to limit the amount of time material is exposed to ambient temperatures.
  - » Select agent destruction requires notification to the responsible official via email at least a week in advance. This notification is required even for exempt quantities. EHS will attend the destruction and schedule a pick-up of the material. See the Institute Bio-Safety Manual for specific procedures.
  - » Human tissue which is unrecognizable as an organ or body part can be disposed of as normal biological waste. Other human tissue may require special handling and/or disposal methods. Researchers whose proposals include the use of human tissue in any form will consult with the Institute Bio-Safety Officer and Hazardous Waste Manager to insure this material is handled appropriately.

- Sharps . Sharps containers are to be placed in standard biological waste bags and boxes, and packaged separately from other wastes. Alternatively, EHS will pick-up unboxed sharps containers for consolidation.

Activities are responsible for providing their own containers for sharps. Such containers must be approved sharps containers. Containers that will not fit in a standard biological waste box must be fitted with a leak-proof gasket.

### **3.2 ACCUMULATION**

Infectious or pathogenic waste must be held in a closed/covered biowaste container and may not be stored longer than 24 hours prior to inactivation. Filled or partially filled biological waste boxes and sharps containers will be marked with the name of the Primary Investigator (PI) and the accumulation start date (they will not be retained longer than 30 days for infectious waste; 6 months for non-infectious)

### **3.3 COLLECTION**

Contact EHS to arrange for collection of biological wastes.

### **3.4 TRANSPORT**

To prevent injuries, spills, and contamination, bags must always be lifted from by the tied end, placed upright in collection boxes, and never dragged on the floor during transfer.

Transport biological waste outside of the laboratory (*i.e.*, to an autoclave) in a closed, leak-proof bag or container; bags must be contained in a leak proof tray.

Do not leave inactivated waste unattended.

Contact EHS with questions or special transport needs.

### 3.5 TRAINING

Training is required for faculty, staff, or students who perform tasks involving the handling of biological materials and wastes prior to their initial involvement of such activities and annually thereafter. The following biological safety training is offered through EHS:

- **General Biosafety** — Safety in the biological laboratory environment is an important mission of all research personnel at Georgia Tech. This course will discuss all the guidelines, regulations, and management practices for conducting and maintaining a safe laboratory environment. Topics covered include review of research by biosafety committees, basic biosafety information, waste disposal, sharps handling, GT shipping rules, and much more. New researchers and students are required to attend this training upon starting research and an annual refresher.
- **Bloodborne Pathogens** — Bloodborne pathogens are of great concern to researchers dealing with human tissues, bone, teeth, organs, cell lines, blood, or other bodily fluids. The course teaches students universal precautions as well as the causes of bloodborne diseases, proper personal protective equipment, and the regulatory basis for a bloodborne pathogens program.
- **Hygiene Plan Writing/Biosecurity** — All research projects require a hygiene plan that will establish procedures for exposure control, work practices, waste handling, and much more. This class will teach attendees the importance of each section and how to make appropriate choices for the plan based on research risks. The class will also discuss biosecurity due to the increasing importance of deterring loss, theft, misuse and release of biological agents.
- **Understanding Biosafety Cabinets** — Many Georgia Tech researchers conduct activities inside of a Biological Safety Cabinet (BSC). The BSC is an important piece of laboratory safety but can be misused. This class will teach the basic types of BSC, proper usage techniques, and maintenance.

Training shall include procedures for handling, storing, and/or disposal of biological waste. Specific, detailed training related to the faculty, staff, or student tasks and potential exposures to biological materials is the responsibility of the project's PI.

## **4. WASTE MANAGEMENT PROCEDURES FOR USED OIL, OIL FILTERS, AND OIL AND SOLVENT LADEN RAGS**

---

The following procedures have been developed for the management and disposal of used oil, oil filters, and oil and solvent laden rags generated at Georgia Tech.

Used oil means any oil that has been refined from crude oil, or any synthetic oil, that has been used, and as a result of such use is contaminated by physical or chemical impurities. Examples of used oil include motor oil, hydraulic fluid, lubricants and oil coolants.

### **4.1 MANAGEMENT OF USED OIL CONTAINERS**

Generators of used oil must store used oil in containers that are in good condition (no severe rusting, apparent structural defects or deterioration) and not leaking (no visible leaks). Remove damaged containers from use or repair immediately. Keep containers (including funnels) closed except when adding or removing used oil.

Use secondary containment structures or other spill management practices to prevent oil from reaching the environment in the event of a leak or a spill.

Used oil containers are potentially subject to the Spill Prevention, Control and Countermeasures rule (40 CFR Part 112). When a container of used oil with a capacity of at least 55 gallons is placed in service, notify EHS so that it can incorporate the container into Georgia Tech's SPCC Plan.

### **4.2 LABELING**

Containers and aboveground tanks used to store used oil must be labeled or marked clearly with the words "Used Oil", and NOT "Waste Oil."

### **4.3 SEGREGATION**

Used oil should not be mixed with solvents or other wastes.

### **4.4 COLLECTION**

Arrange for pickup and disposal when the container is full by contacting EHS.

### **4.5 USED OIL FILTERS**

Used oil filters should be placed in a leak proof container for collection by EHS. Contact EHS for pick up and disposal.

### **4.6 OIL AND SOLVENT LADEN RAGS**

Oil and solvent laden rags are potentially subject to hazardous waste regulation, meaning that they need to be collected in a

proper container that is kept closed and labeled, and managed under accumulation requirements and sent to a proper disposal facility. Free liquids must be managed accordingly, including in accordance with hazardous waste regulations if applicable. As such, Georgia Tech personnel generating oil and solvent laden rags should implement the following practices:

- Rags intended for disposal must be managed as chemical waste as described in Section 1 since the rags could be a hazardous waste.
- Maintain rags in a closed, labeled container as described in Section 1.
- Use wringing or other type of extraction process to recover excess solvent and achieve “no free liquids” state. Reuse the liquid where possible. Allowing oil or solvents to evaporate to achieve a “no free liquids” state is not permitted.
- Spray a minimum amount of solvent onto rags instead of soaking rags.
- Store rags in a closed, labeled container (“used shop rags” or similar).
- Contaminated rags or commercial wipes regulated as hazardous waste may not be burned.
- Absorbents used to clean up oil spills should be managed as chemical waste. Upon collection, contact EHS for collection and disposal.

#### **4.7 TRAINING**

All individuals whose duties include the identification, handling, and management of used oil shall participate in an awareness training program prior to their initial involvement of such activities and annually thereafter. The training program will include topics such as:

- Identification of used oil
- Proper used oil container management
- Used oil pick-up and disposal procedures
- Used oil waste reduction.

Contact EHS for used oil training needs.

**If there are any questions about your activity, contact EHS.**

## 5. WASTE MANAGEMENT PROCEDURES – USED FLUORESCENT LAMPS AND LIGHTING BALLASTS

---

The following procedures have been developed for the management and disposal of used fluorescent lamps or other mercury containing lamps (*e.g.*, HID bulbs) and ballasts at Georgia Tech. This procedure does not apply to incandescent lamps. Used incandescent lamps can be disposed of in normal trash.

### 5.1 MANAGEMENT OF USED MERCURY CONTAINING LAMPS

#### Containers

Generators of used lamps are responsible for their packaging and storage. Containers or packages must be structurally sound, adequate to prevent breakage, and compatible with the contents of the lamps. Bulbs may be packaged in original containers (use the box the bulbs were supplied in with packing material removed). If appropriate packaging is not available, contact EHS for fiber drums.

The container must be kept closed except when adding bulbs to the container.

Georgia Tech does not approve of the use of a fluorescent bulb crusher. C

#### Labeling

Containers of used lamps must be labeled with the words “Universal Waste – Lamps”, “Used Lamp(s)” or “Waste Lamp(s)”. The labels must be dated when the first lamp is placed in the container. Pre-printed labels are available from EHS.

#### Segregation

Lamps must be stored in a manner to prevent breakage or damage to the lamps. Identify a safe storage area to prevent the lamps from being accidentally broken or crushed before they are picked up. Any broken bulbs will be immediately cleaned up with the residue placed in a suitable container, marked as to contents and disposed of with spent bulbs.

#### Collection

Georgia Tech cannot store used lamps for longer than 1 year. Therefore, contact EHS when a used lamp container is full, or when the container has been in use for 9 months (based on the start date on the label), whichever is earlier.

EHS will pick-up lamps as requested; alternately they may be transported to the Hazardous Waste Accumulation Facility.

### 5.2 MANAGEMENT OF BALLASTS

Georgia Tech’s policy is to recycle all ballasts, with an approved vendor. Do not dispose of ballasts in the trash. In general, it should be assumed that ballasts manufactured through 1978 contain Polychlorinated Biphenyls (PCBs). However, some ballasts



manufactured after 1978 may contain PCBs or a chemical called DEHP. All light ballasts manufactured from 1978 to 1998 are required by the USEPA to be marked by the manufacturer with the words "No PCBs". For these reasons, fluorescent lighting ballasts that are not specifically labeled "No PCBs" must be suspected to contain PCBs and managed as such. Modern electronic ballasts, while not required to have any explicit markings, can be assumed to contain no PCBs. The following website identifies some of the common ballast manufacturers and the associated codes that may indicate the presence of PCBs:

<http://www.pcbdisposalinc.com/images/pdfs/ballasts.pdf>.

Should you discover a leaking ballast:

- Handle with gloves
- Place ballast (and gloves) in a plastic bag.
- Wash hands thoroughly
- Contact EHS for disposal

### **Labeling**

Used ballasts should be placed into approved containers provided by EHS or our ballast recycling vendor. PCB ballasts should be placed into the drums that have the yellow "Caution Contains PCBs (Polychlorinated Biphenyls)" label. Non-PCB ballasts should be placed into drums without the yellow label. A label that otherwise identifies the contents of the container is recommended for non-PCB ballast containers. Pre-printed labels are available from EHS. The label should include the date when the first ballast was placed in the container.

### **Segregation**

Segregate containers of PCB containing ballasts from non-PCB containing ballast. Store PCB and non-PCB ballast drums in a secure, dry area away from public access.

### **Collection**

Keep each container closed unless ballasts are being added. Use a lid, ring and bolt (or equivalent) to accomplish. Fill each PCB and non-PCB ballast drum to  $\frac{3}{4}$  full. There are no storage time limitations for non-PCB ballasts; however, please contact EHS when your container is  $\frac{3}{4}$  full. Georgia Tech must remove a container of PCB ballasts within 9 months of the first ballast being placed into the container. Therefore, contact EHS in advance to arrange for collection.

## **5.3 TRAINING**

Georgia Tech faculty, staff and students who handle or have responsibility for managing mercury containing lamps and/or ballasts must participate in an awareness training session that describes proper handling and emergency procedures. Training

must be conducted prior to initial involvement in these activities, and annually thereafter.

EHS has developed an on-line training program accessible through OOD to meet these training needs.

,

## 6. WASTE MANAGEMENT PROCEDURES – USED BATTERIES

---

Georgia Tech recycles all batteries, regardless of type or size. Improper disposal of batteries can lead to contamination of soil and ground water. All batteries can, and should be, recycled. Those with the  “three chasing arrows” symbol must be recycled.

The following procedures have been developed for the management and disposal of used batteries at Georgia Tech. In addition, please refer to <http://www.stewardship.gatech.edu/batteries.php> for additional guidance.

### 6.1 MANAGEMENT OF BATTERIES

Lead-acid batteries (automotive type or sealed), may be exchanged with vendors supplying replacement batteries or alternatively are disposed of by EHS. These batteries should be managed in the same manner as other batteries, including labeling practices. Contact EHS for disposal.

Smaller, portable batteries may be collected by individual activities or dropped off at one of several battery recycling points. Battery recycling points have been established at:

- 1) Student Center Information Desk
- 2) Student Center Commons – Burdell's Bookstore (Cashier Counter)
- 3) Library – Security Desk
- 4) Campus Recreation Center – ORGT – Outdoor Recreation at Georgia Tech (Back of CRC, lower level, near volleyball courts )
- 5) Barnes & Noble @Tech Square (Book Cashier Counter).

Activities who would like to set up their own collection activities should contact EHS. EHS will provide the supplies and instructions on how to do so safely and legally.

### 6.2. BATTERY SAFETY.

Even "dead" batteries retain some charge which, under the correct circumstances could cause fires and or explosions. To preclude such an event all batteries, with the exception of alkaline batteries rated at 9 volts or less, must have their terminals protected. This may be done by taping the terminals with electrical tape or placing the individual battery in a plastic bag.

### **6.3. LABELING**

Label each battery, or the container in which the batteries are contained, with one of the following phrases: “Universal Waste—Battery(ies),” or “Waste Battery(ies),” or “Used Battery(ies).” and the date the battery was taken out of service.

### **6.4 SEGREGATION**

Batteries must be stored in a manner to prevent a release. Identify a safe storage area to prevent the batteries and the containers from being damaged before they are picked up.

Leaking batteries require special handling. Contact EHS to report leaking batteries and to obtain guidance on proper disposal.

### **6.5 COLLECTION**

Georgia Tech cannot store used batteries for longer than 1 year. Therefore, contact EHS when a battery box is full, or when the container has been in use for 9 months (based on the start date on the label), whichever is earlier.

### **6.6 TRAINING**

Georgia Tech faculty, staff and students who handle or have responsibility for managing used batteries must participate in an awareness training session that describes proper handling and emergency procedures. Training must be conducted prior to initial involvement in these activities, and annually thereafter. EHS has developed a PowerPoint presentation to meet these training needs. Please contact EHS with your training needs.

## 7. HAZARDOUS WASTE MANAGEMENT PROCEDURES – SPILLS/INCIDENTS

---

Georgia Tech faculty, staff and students should expect and be prepared to deal with “routine” spills of materials (chemicals, solvents, oils, *etc.*). Activities are encouraged to purchase and position appropriate pre-packaged “spill kits” and develop a spill response plan specific to their situation. A spill response template is available on EHS’s website for guidance:

[http://www.ehs.gatech.edu/emergency/spill\\_template.doc..](http://www.ehs.gatech.edu/emergency/spill_template.doc..)

Absorbents and/or contaminated material from incidents will be collected in an appropriate container and disposed of in the same manner as other hazardous chemical waste.

Request assistance if required. Generally, conditions requiring assistance include, but are not limited to:

- Clean-up cannot be accomplished without harm to yourself or others
- Questionable levels of respiratory exposure
- Significant amounts of highly hazardous material
- Unidentified spilled material
- Medical assistance is required

If assistance is required:

- Contact EHS.
- If immediate assistance is required: Contact Campus Police at (404) 894-2500.
- Arrange to meet responder and remain in area until released.

## 8. WASTE MANAGEMENT PROCEDURES – AEROSOL CANS

---

Georgia Tech uses a wide variety of products that come in aerosol "spray" cans ("spray cans") such as: cleaners, paints, pesticides, lubricants, and polishes. Aerosol cans contain both the product and a pressurized propellant. In many cases, these products have hazardous characteristics, such as ignitability (*e.g.*, paints, lubricants) or toxicity (*e.g.*, pesticides, chlorinated cleaning products). In addition, many propellants are mixtures of ignitable gases, such as propane and butane. The aerosol cans themselves are pressurized and, therefore, present a safety hazard if not properly managed.

The purpose of this procedure is to provide Georgia Tech employees with guidelines on managing waste aerosol cans and their contents.

### 8.1 WHICH AEROSOL CANS ARE REGULATED AS CHEMICAL WASTE?

Disposing of an aerosol can that still has product inside the can in the regular trash can be considered improper disposal of hazardous waste. To comply with hazardous waste regulations, non-empty aerosol cans, or depressurized aerosol cans that contain materials, should be collected, managed as chemical waste, and disposed of through EHS.

### 8.2 WHICH AEROSOL CANS ARE NOT REGULATED AS CHEMICAL WASTE?

Aerosol cans that are still in use and that contain usable product are not yet considered wastes.

Aerosol cans that are emptied and fully depressurized through normal use can be disposed as normal waste. These cans must be completely empty, and should not be emptied by spraying them into the air, into a rag or towel, or onto the ground. Per Georgia Tech's recycling vendor, empty aerosol cans cannot be recycled so please do not place them in recycling receptacles.

### 8.3 PUNCTURING AEROSOL CANS

Aerosol can puncturing devices may be used to completely empty aerosol cans and render them non-reactive (depressurized). An aerosol puncturing system sometimes can be a cost-effective and safe way to minimize costs associated with the disposal of non-empty aerosol cans. However, the use of a puncturing device may be creating a secondary waste stream that needs to be managed in accordance with applicable regulations. As such, Georgia Tech does not recommend the use of puncturing devices without its consent. Contact EHS with questions regarding puncturing devices.

## 9. WASTE MANAGEMENT PROCEDURES – DRAIN AND TRASH DISPOSAL OF MATERIAL BY USERS

---

The wastewater from laboratory sinks, floor drains, and other areas within Georgia Tech buildings enters the public sewer system, where it flows to a publicly owned treatment works (POTW) operated by the Atlanta Watershed Authority. There the wastewater receives chemical and biological treatment before being discharged.

To protect water quality and the biological treatment processes, the Atlanta Watershed Authority enforces strict limits on contaminants and pollutants in the water discharged to sewers. Exceeding the stipulated discharge limits could subject Georgia Tech to administrative, or even criminal, penalties. Plumbing systems, even if “chemically resistant,” or equipped with “dilution tanks,” are capable of handling only incidental quantities of waste; they are NOT designed for use as a primary disposal method.

All members of the Georgia Tech community are responsible for maintaining acceptable quality in our wastewater discharges. Laboratory personnel in particular must make special efforts to keep certain items out of the sinks and floor drains. Questions about these policies should be directed to EHS. Described below are the substances that may be disposed of through drains.

Bench top procedures designed to make material non-hazardous or less hazardous, such as acid-base neutralizations should be undertaken with caution. EHS will permit drain disposal of neutralized, acidic and caustic aqueous solutions. The neutralized aqueous solution must have a final pH value between 6 and 9. EHS will also permit drain disposal of common salts, sugars and agars in both liquid and solid forms. For solids, the material must be dissolved in tap water.

For chemicals that pose little or no hazard in dilute aqueous solution, which includes many simple organic and inorganic compounds, as well as common inorganic chemicals, and most biological metabolites and nontoxic cellular constituents (proteins, nucleic acids, carbohydrates, soluble fats, and their precursors and catabolites): Up to approximately 100 g of solute per laboratory per day (e.g. 100 g of sodium hypochlorite in one liter of water). Also included in this category are:

- Soaps/detergents.
- Bleach/Wescodyne™/Cidex™ /Quatricide® solutions.
- Infectious/biological materials that have been properly treated as described in each laboratory’s registration protocols.
- Non-contaminated growth media.
- Purified biological materials such as amino acids and proteins in aqueous or buffer solutions.
- Sugars and sugar alcohols (polyols) such as xylitol and sorbitol.
- Buffer solutions with a pH between 6 and 9.

For chemicals that pose moderate hazard in dilute aqueous solution, such as acrylamide, trypan blue, and inorganic salts.

- Not greater than 1 g of solute per laboratory per day.

For shops, studios, kitchens, janitorial areas, ground, athletic operations, maintenance operations, and construction sites, chemicals and wastewater of little or no hazard in dilute solutions are suitable for disposal down the drain in quantities that would be expected in normal operations (for example, latex paint brush wash-water or a bucket of mop water). Large quantity wastewater discharges from physical plant equipment can be drain disposed if approved by the City of Atlanta (for example, cooling tower discharges and boiler blow-down).

The following are examples of drain disposable chemicals and process wastewater for shops, physical plant operations, kitchens, janitorial, grounds, and athletic operations.

- Latex paint wash-water from the rinsing of brushes, rollers, sprayers, and other water base painting equipment washing.
- Drywall compound washwater.
- Commercially available custodial and cleaning products such as soaps and detergents if they are used in accordance with the manufacturer instructions.
- Super-chlorinated water used to disinfect new plumbing.
- Garbage truck and dumpster wash-out.

All other materials must be collected and managed as chemical waste.

Standard laboratory articles (*e.g.*, gloves, pads, wipes, rags) contaminated with non-hazardous chemicals may be disposed via the trash. In order to dispose of contaminated laboratory debris via the trash, it must:

- 1) meet the following characteristics:
  - › contain no radioactive materials. Contact the Radiological Safety Office at (404) 894-3605 for the disposal of radioactive materials
  - › contain no biological hazards
  - › be free of excess or free-flowing powders (see below).
  - › refer to Section 4 of these procedures for guidance regarding solvent laden wipe and rags.
- 2) if possible, be consolidated in a bag or other container to minimize potential releases, and
- 3) be placed in a normal trash receptacle.

Note: It is important to be conscious of the potential harm and alarm which may result from the disposal of contaminated laboratory debris with excess or free-flowing powders. If a



contaminated item contains excess powders which may result in the forming of “dust clouds” during its handling, then these items should be managed and disposed as a chemical waste in accordance with the Waste Disposal Procedures.

Containers that have been emptied using normal practices (*e.g.*, pouring) are generally not considered hazardous and can be discarded in normal trash. Note that containers that held highly hazardous materials are considered hazardous even when empty and shall be handled as such.

## 10. REFRIGERANTS (OZONE DEPLETING SUBSTANCES)

---

Containers (*e.g.*, cylinders) of unused refrigerants or appliances containing refrigerants **should not be disposed in the trash. In addition, refrigerants should not be vented to the atmosphere.** Cylinders containing refrigerants should be returned to the supplier. Refrigerant from appliances must be reclaimed by certified technicians prior to disposal of the appliance.

## 11. SELF-TRANSPORT OF HAZARDOUS MATERIALS

---

The US Department of Transportation (USDOT) regulates and restricts the transportation of hazardous materials over public roads and highways. Occasionally, Georgia Tech employees desire to self-transport such material and the questions of legality and appropriate procedures arise. It is possible to legally do this, provided certain conditions are met. The legal reference is 49 CFR 173.6, Materials of Trade Exception. Basically, this regulation allows the transport of limited amounts of hazardous materials necessary for the conduct of business, as long as that business isn't transportation, without requiring such things as: a Commercial Drivers License, formal shipping papers, placards, etc. But there are certain restrictions. The following provides an overview of allowable amounts, required packaging, and other provisions. There are more stringent requirements for certain materials. Please contact EHS with questions.

### **Material Limits**

For most chemicals: Single containers of no more than 30 kg (66 pounds) or 30 L (8 gallons).

For gas cylinders: Gross weight of cylinder no more than 220 pounds.

Total GROSS weight of all hazardous material is 200 kg (400 lbs)

Things You May Not Transport: Explosives, Pyrophorics, material classified as Inhalation Hazards.

### **Required Packaging**

Packages must be leak tight for liquids and gases, sift proof for solids, securely closed, secured against movement, and protected against damage.

Each material must be packaged in the manufacturer's original packaging, or a packaging of equal or greater strength and integrity.

Additional packaging is not required for "receptacles" (e.g., cans and bottles) that are secured against movement in cages, carts, bins, boxes or compartments. Note, however, biological specimens may require inner and outer packaging and secondary containment is recommended.

### **Other Requirements**

The operator of the motor vehicle must know what he/she is carrying, have a copy of the pertinent Material Safety Data Sheet, and be prepared to deal with spilled material.

## **Transport in Private Vehicles**

Georgia Tech employees are covered by state auto liability insurance while operating privately owned vehicles within the scope of their official duties or employment. However, privately owned vehicles are not covered for physical damage that may occur in the scope of employees' official duties or employment. Check with your own insurance carrier for specifics.

## APPENDIX A HIGHLY HAZARDOUS CHEMICALS LIST

### "Highly Hazardous Chemicals"

- Chemical Substances which Have Been Specifically Identified by the Environmental Protection Agency (EPA) require special handling.
- All containers which contain, or once contained, this material must be disposed of through Hazardous Waste Channels.
- No more than 1 quart or 1 kilogram of this waste may be accumulated at or near the point of generation, i.e., laboratory
- The table below lists those chemicals identified by the EPA as falling in this category
- Any chemical, not on this list, which has an LD50 of 50mg/kg (rat) shown on the MSDS must be handled in the same manner.
- Any research chemical or product which, although not formally tested, the researcher believes to fall in this category must be handled in the same manner.

EPA "ACUTE" HAZARDS	CAS	EPA CODE
NAME		
Acetaldehyde, chloro-	107-20-0	P023
Acetamide, 2-fluoro	640-19-7	P057
Acetamide, N-(aminothioxomethyl)-	591-08-2	P002
Acetic acid, fluoro-, sodium salt	62-74-8	P058
1-Acetyl-2-thiourea	591-08-2	P002
Acrolein	107-02-8	P003
Aldicarb	116-06-3	P070
Aldicarb sulfone	1646-88-4	P203
Aldrin	309-00-2	P004
Allyl alcohol	107-18-6	P005
Aluminum phosphide	20859-73-8	P006
5-(Aminomethyl)-3-isoxazolol	2763-96-4	P007
4-Aminopyridine	504-24-5	P008
Ammonium picrate	131-74-8	P009
Ammonium vanadate	7803-55-6	P119
Argentate(1-), bis (cyano-C), potassium	506-61-6	P099
Arsenic Acid H <sub>3</sub> AsO <sub>4</sub>	7778-39-4	P010
Arsenic Oxide As <sub>2</sub> O <sub>3</sub>	1327-53-3	P012
Arsenic Oxide As <sub>2</sub> O <sub>5</sub>	1303-28-2	P011
Arsenic pentoxide	1303-28-2	P011
Arsenic trioxide	1327-53-3	P012
Arsine, diethyl	692-42-2	P036
Arsonous dichloride, phenyl-	696-28-6	P054
Aziridine	151-56-4	P067
Barium cyanide	542-62-1	P013
Benzene, (chloromethyl-)	100-44-7	P028
Benzeneamine, 4-chloro-	106-47-8	P024
Benzeneamine, 4-nitro-	100-01-06	P077
1,2-Benzenediol, 4-[hydroxy-2-(methylamino)ethyl]-, (R)-	51-43-4	P042
Benzeneethanamine, alpha,alpha-dimethyl-	122-09-8	P046

EPA "ACUTE" HAZARDS	CAS	EPA CODE
NAME		
Benzenethiol	108-98-5	P014
7-Benzofuranol, 2,3-dihydro-2,2-dimethyl-, methylcarbamate	1563-66-2	P127
Benzoic acid, 2-hydroxy-, compd. with (3aS-cis)-1,2,3,3a,8,8a-hexahydro-1,3a,8-trimethylpyrrolo[2,3-b]indol-5-yl methylcarbamate ester (1:1)	57-64-7	P188
2H-1-Benzopyran-2-one, 4-hydroxy-3-(3-oxo-1-phenylbutyl)- & salts, when present at concentrations greater than 0.3%	81-81-2	P001
Benzyl chloride	100-44-7	P028
Beryllium powder	7440-41-7	P015
Bromoacetone	598-31-2	P017
Brucine	357-5703	P018
2-Butanone, 3,3-dimethyl-1-(methylthio)-, O-[(methylamino)carbonyl] oxime	39196-18-4	P045
Calcium cyanide	592-01-8	P021
Calcium cyanide Ca(CN) <sub>2</sub>	592-01-8	P021
Carbamic acid, [(dibutylamino)-thio)methyl-, 2,3-dihydro--2,2-dimethyl-7-benzofuranyl ester	55285-14-8	P189
Carbamic acid, dimethyl-, 1-[(dimethyl-amino)carbonyl]-5-methyl-1H-pyrazol-3-yl ester	644-64-4	P191
Carbamic acid, dimethyl-, 3-methyl-1-(1-methylethyl)-1H-pyrazol-5-yl-ester	119-38-0	P192
Carbamic acid, methyl-, 3-methylphenyl ester	1129-41-5	P190
Carbofuran	1563-66-2	P127
Carbon disulfide	75-15-0	P022
Carbonic dichloride	75-44-5	P095
Carbosulfan	55285-14-8	P189
Chloroacetaldehyde	107-20-0	P023
p-Chloroaniline	106-47-8	P024
1-(o-Chlorophenyl) thiourea	5344-82-1	P026
3-Chloropropionitrile	542-76-7	P027
Copper cyanide	544-92-3	P029
Copper cyanide Cu(CN)	544-92-3	P029
Cyanides (soluable cyanide salts), not otherwise specified		P030
Cyanogen	460-19-5	P031
Cyanogen chloride	506-77-4	P033
Cyanogen chloride (CN)Cl	506-77-4	P033
m-Cumenyl methylcarbamate	64-00-6	P202
2-Cyclohexyl-4,6-dinitrophenol	131-89-5	P034
Dichloromethyl ether	542-88-1	P016
Dichlorophenylarsine	696-28-6	P036
Dieldrin	60-57-1	P037
Diethylarsine	692-42-2	P038
Diethyl-p-nitrophenyl phosphate	311-45-5	P041
O,O-Diethyl O-pyrazinyl phosphorothioate	297-97-2	P040
Diisopropylfluorophosphate (DFP)	55-91-4	P043
1,4,5,8-Dimethanonaphthalene, 1,2,3,4,10,10-hexa-chloro-1,4,4a,5,8,8a-hexahydro-(1alpha,4 alpha,4abeta,5 alpha,8alpha,8beta)-	309-00-2	P004
1,4,5,8-Dimethanonaphthalene, 1,2,3,4,10,10-hexa-chloro-1,4,4a,5,8,8a-hexahydro-,(1alpha,4alpha,4abeta,5beta,8beta,8beta)-	465-73-6	P060

EPA "ACUTE" HAZARDS	CAS	EPA CODE
NAME		
2,7:3,6-Dimethanonaphth[2,3-b]oxirene, 3,4,5,6,9,9-hexachloro-1a,2,2a,3,6,6a,7,7a-octahydro-, (1aalpha,2beta,2alpha,3beta,6beta,6abeta,7beta,7aalpha)-	60-57-1	P037
2,7:3,6-Dimethanonaphth[2,3-b]oxirene, 3,4,5,6,9,9-hexachloro-1a,2,2a,3,6,6a,7,7a-octahydro-, (1aalpha,2beta,2abeta,3alpha,6alpha,6abeta,7beta,7aalpha)-, & metabolites	72-20-8	P051
Dimethoate	60-51-5	P044
alpha, alpha-Dimethylphenethylamine	122-09-8	P046
Dimetilan	644-64-4	P191
Dinoseb	88-85-7	P020
4,6-Dinitro-o-cresol, & salts	534-52-1	P047
2,4-Dinitrophenol	51-28-5	P048
Diphosphoramidate, octamethyl-	152-16-9	P085
Diphosphoric acid, tetraethyl ester	107-49-3	P111
Disulfoton	298-04-4	P039
Dithiobiuret	541-53-7	P049
1,3-Dithiolane-2-carboxaldehyde,2,4-dimethyl-,O-[(methylamine)-carbonyl]oxime	26419-73-8	P185
Endosulfan	115-29-7	P050
Endothall	145-73-3	P088
Endrin	72-20-8	P051
Endrin, & metabolites	72-20-8	P051
Epinephrine	51-43-4	P042
Ethanedinitrile	460-19-5	P031
Ethanimidothioic acid, 2-(dimethylamine)-N-[[[(methylamino) carbonyl]oxy]-2-oxo-, methyl ester	23135-22-0	P194
Ethanimidothioic, N-[[[(methylamine)carbonyl]oxy]-,methyl ester	16752-77-5	P066
Ethyl cyanide	107-12-0	P107
Ethyleneimine	151-66-4	P054
Famphur	52-85-7	P097
Fluorine	7782-41-4	P056
Fluoroacetamide	640-197	P057
Fluoroacetic acid, sodium salt	62-74-8	P058
Fomparanate	17702-57-7	P197
Formetanate hydrochloride	23422-53-9	P198
Fulminic acid, mercury(2+) salt	628-86-4	P065
Heptachlor	76-44-8	P059
Hexaethyl tetraphosphate	757-58-4	P062
Hydrazine, methyl	60-34-4	P068
Hydrazinecarbothioamide	79-19-6	P116
Hydrocyanic acid	74-90-8	P063
Hydrogen cyanide	74-90-8	P063
Hydrogen phosphide	7803-51-2	P096
Isodrin	465-73-6	P060
Isolan	119-38-0	P192

EPA "ACUTE" HAZARDS	CAS	EPA CODE
NAME		
3-Isopropylphenyl N-methylcarbamate	64-00-6	P202
3(2H)-Isoxazolone, 5-(aminomethyl)-	2763-96-4	P007
Manganese, bis(dimethylcarbamodithioato-S,S'-)	15339-36-3	P196
Manganese, dimethyldithiocarbamate	15339-36-3	P196
Mercury fulminate	628-86-4	P065
Mercury, (acetato-O)phenyl-	62-38-4	P092
Methanamine, N-methyl-N-nitroso-	62-75-9	P082
Methane, Isocyanato-	624-83-9	P064
Methane, oxybis[chloro-	542-88-1	P016
Methane, tetranitro-	509-14-8	P112
Methanethiol, trichloro-	75-70-7	P118
Methanimidamide, N,N-dimethyl-N'-[3-[[[(methylamine)-carbonyl]oxy]phenyl]-, monohydrochloride	23422-53-9	P198
Methanimidamide, N,N-dimethyl-N'-(2-methyl-4-[[[(methylamine)carbonyl]oxy]phenyl]-	17702-57-7	P197
6,9-Methano-2,4,3-benzodioxathiepin, 6,7,8,9,10,10-hexachloro-1,5,5a,6,9,9a-hexahydro-,3-oxide	115-29-7	P050
4,7-Methano-1H-indene, 1,4,5,6,7,8,8-heptachloro-3a,4,7,7a-tetrahydro-	76-44-8	P059
Methiocarb	2032-65-7	P199
Methomyl	16752-77-5	P066
Methyl hydrazine	60-34-4	P068
Methyl isocyanate	624-83-9	P064
2-Methylactonitrile	75-86-5	P069
Methyl parathion	298-00-0	P071
Metolcarb	1129-41-5	P190
Mexacarbate	315-18-4	P128
alpha-Naphthylthiourea	86-88-4	P072
Nickel carbonyl	13463-39-3	P073
Nickel carbonyl Ni(CO) <sub>4</sub>	13463-39-3	P073
Nickel cyanide	557-19-7	P074
Nickel cyanide Ni(CN) <sub>2</sub>	557-19-7	P074
Nicotine, & salts	54-11-5	P075
Nitric oxide	10102-43-9	P076
p-Nitroaniline	100-01-6	P077
Nitrogen dioxide	10102-44-0	P078
Nitrogen oxide NO	10102-43-9	P076
Nitrogen oxide NO <sub>2</sub>	10102-44-0	P078
Nitroglycerine	55-63-0	P081
N-Nitrosodimethylamine	62-75-9	P082
N-Nitrosomethylvinylamine	4549-40-0	P084
Octamethylpyrophosphoramidate	152-16-9	P085
Osmium oxide OsO <sub>4</sub>	20816-12-0	P087
Osmium tetroxide	20816-12-0	P087
7-Oxabicyclo[2.2.1]heptane-2,3-dicarboxylic acid	145-73-3	P088
Oxamyl	23135-22-0	P194



EPA "ACUTE" HAZARDS	CAS	EPA CODE
NAME		
Parathion	56-38-2	P089
Pheno, 2-(1-methylpropyl)-4,6-dinitro-	88-85-7	P020
Phenol, (3,5-dimethyl-4-(methylthio)-, methylcarbamate	2032-65-7	P199
Phenol, 2,4,6-trinitro-, ammonium salt	131-74-8	P009
Phenol, 2,4-dinitro-	51-28-5	P048
Phenol, 2-cyclohexyl-4,6-dinitro-	131-89-5	P034
Phenol, 2-methyl-4,6-dinitro-, & salts	534-52-1	P047
Phenol, 3-(1-methylethyl)-,methyl carbamate	64-00-6	P202
Phenol, 3-methyl-5-(1-methylethyl)-, methyl carbamate	2631-37-0	P201
Phenol, 4-(dimethylamino)-3,5-dimethyl-, methylcarbamate (ester)	315-18-4	P128
Phenylmercury acetate	62-38-4	P092
Phenylthiourea	103-85-5	P093
Phorate	298-02-2	P094
Phosgene	75-44-5	P095
Phosphine	7803-51-2	P096
Phosphoric acid, diethyl 4-nitrophenyl ester	311-45-5	P041
Phosphorodithioic acid, O,O-diethyl S-[(ethylthio)methyl] ester	298-02-2	P094
Phosphorodithioic acid, O,O-diethyl S-[2-(ethylthio)ethyl] ester	298-04-4	P039
Phosphorodithioic acid, O,O-dimethyl S-[2-(methylamin)-2-oxoethyl] ester	60-51-5	P044
Phosphorofluoridic acid, bis (1-methylethyl) ester	55-91-4	P043
Phosphorothioic acid, O,O,-dimethyl O-(4-nitrophenyl) ester	298-00-0	P071
Phosphorothioic acid, O,O-diethyl O-(4-nitrophenyl) ester	56-38-2	P089
Phosphorothioic acid, O,O-diethyl O-pyrazinyl ester	297-97-2	P040
Phosphorothioic acid, O-[4-[(dimethylamino)sulfonyl]phenyl] O,O-dimethyl ester	52-85-7	P097
2-Propananone, 1-bromo-	598-31-2	P017
Physostigmine	57-47-6	P204
Physostigmine salicylate	57-64-7	P188
Plumbane, tetraethyl-	78-00-2	P110
Potassium cyanide	151-50-8	P098
Potassium cyanide K(CN)	151-50-8	P098
Potassium silver cyanide	506-61-6	P099
Promecarb	2631-37-0	P201
Propanal, 2-methyl-2-(methyl-sulfonyl)-, O-[(methylamino)carbonyl]oxime	1646-88-4	P203
Propanal, 2-methyl-2-(methylthio)-, O-[(methylaino) carbonyl] oxime	116-06-3	P070
Propanenitrile	107-12-0	P101
Propanenitrile, 2-hydroxy-2-methyl-	75-88-5	P069
Propanenitrile, 3-chloro-	542-76-7	P027
1,2,3-Propanetriol, trinitrate	55-63-0	P081
2-Propenal	107-02-8	P003
2-Propen-1-ol	107-18-6	P005
Propargyl alcohol	107-19-7	P102
1,2-Propylenimine	75-55-8	P067
2-Propyn-1-ol	107-19-7	P102
4-Pyridinamine	504-24-5	P008

EPA "ACUTE" HAZARDS	CAS	EPA CODE
NAME		
Pyridine, 3-(1-methyl-2-pyrrolidinyl)-, (S), & salts	54-11-5	P075
Pyrrolo[2,3-b]indol-5-ol, 1,2,3,3a,8,8a-hexahydro-1,3a,8-trimethyl, methylcarbamate (ester), (3aS-cis)	57-47-6	P204
Selenious acid, dithallium (1+) salt	12039-52-0	P114
Selenourea	630-10-4	P103
Silver cyanide	506-64-9	P104
Silver cyanide Ag(CN)	506-64-9	P104
Sodium azide	26628-22-8	P105
Sodium cyanide	143-33-9	P106
Sodium cyanide Na(CN)	143-33-9	P106
Strychnidin-10-one, & salts	57-24-9	P108
Strychnidin-10-one, 2,3-dimethoxy-	357-57-3	P018
Strychnine, & salts	57-24-9	P108
Sulfuric acid, dithallium (1+) salt	7446-18-6	P115
Tetraethyl lead	78-00-2	P110
Tetraethyl pyrophosphate	107-49-3	P111
Tetraethyldithiopyrophosphate	3689-24-5	P109
Tetranitromethane	509-14-8	P112
Tetraphosphoric acid, hexaethyl ester	757-58-4	P062
Thallic oxide	1314-32-5	P113
Thallium (1) selenite	12039-52-0	P114
Thallium (1) sulfate	7446-18-6	P115
Thallium oxide Tl <sub>2</sub> O <sub>3</sub>	1314-32-5	P113
Thiodiphosphoric acid, tetraethyl ester	3689-24-5	P109
Thiofanox	39196-18-4	P045
Thiomidodicarbonic diamide [(H <sub>2</sub> N)C(S)] <sub>2</sub> NH	541-53-7	P049
Thiophenol	108-98-5	P014
Thiosemicarbazide	79-19-6	P116
Thiourea, (2-chlorophenyl)-	5344-82-1	P026
Thiourea, 1-naphthalenyl-	86-88-4	P072
Thiourea, phenyl-	103-85-5	P093
Tirpate	26419-73-8	P185
Toxaphene	8001-35-2	P123
Trichloromethanethiol	75-70-7	P118
Vanadic acid, ammonium salt	7803-55-6	P119
Vanadium oxide V <sub>2</sub> O <sub>5</sub>	1314-62-1	P120
Vandadium pentoxide	1314-62-1	P120
Vinylamine, N-methyl-N-nitroso-	4549-40-0	P084
Warfarin, & salts when present at concentrations greater than 0.3%	81-81-2	P001
Zinc cyanide	557-21-1	P121
Zinc cyanide Zn(CN) <sub>2</sub>	557-21-1	P121
Zinc phosphide Zn <sub>3</sub> P <sub>2</sub> , when present at concentrations greater than 10%	1314-84-7	P122
Zinc, bis (dimethylcarbamodithioato-S,S')	137-30-4	P205
Ziram	137-30-4	P205

EPA "ACUTE" HAZARDS	CAS	EPA CODE
NAME		
Wastes from the production or use of tri- or tetrachlorophenol, or of intermediates used to produce their pesticide derivatives.		F020
Wastes from the production or use of pentachlorophenol, or of intermediates used to produce its derivatives.		F021
Wastes from the use of tetra-, penta-, or hexachlorobenzenes under alkaline conditions.		F022
Wastes from the production of materials on equipment previously used for the production or use of tri- and/or tetrachlorophenols.		F023
Wastes from the production of materials on equipment previously used for the production or use of tetra, penta- or hexachlorobenzene under alkaline conditions.		F026
Tri-, tetra-, or pentachlorophenol or formulations containing compounds derived from these chlorophenols.		F027

## APPENDIX B Laboratory Configurations

Situation	Acceptable	Not Acceptable (rationale)
Single lab, one PI	Waste is collected and retained within the confines of the lab space	Waste is transported across a public corridor to another location (waste would not be under the control of the operator)

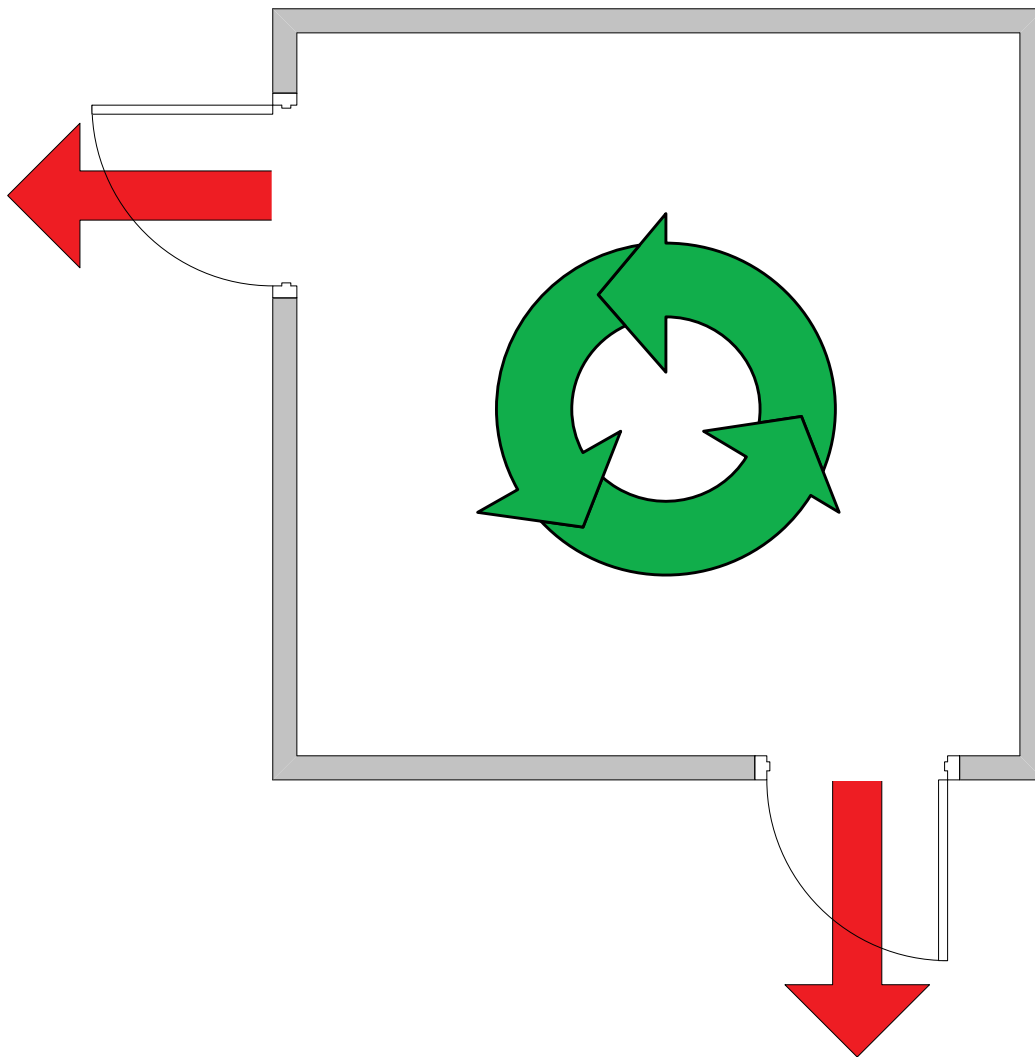

<b>Situation</b>	<b>Acceptable</b>	<b>Not Acceptable (rationale)</b>
Contiguous, connected labs with single PI	Waste is collected and retained within the confines of the lab space.	Waste is transported across a public corridor to a location under the control of another PI. (personnel in lab space A cannot be held responsible for the management provided by those in Lab B; inability to maintain accountability of each generator)

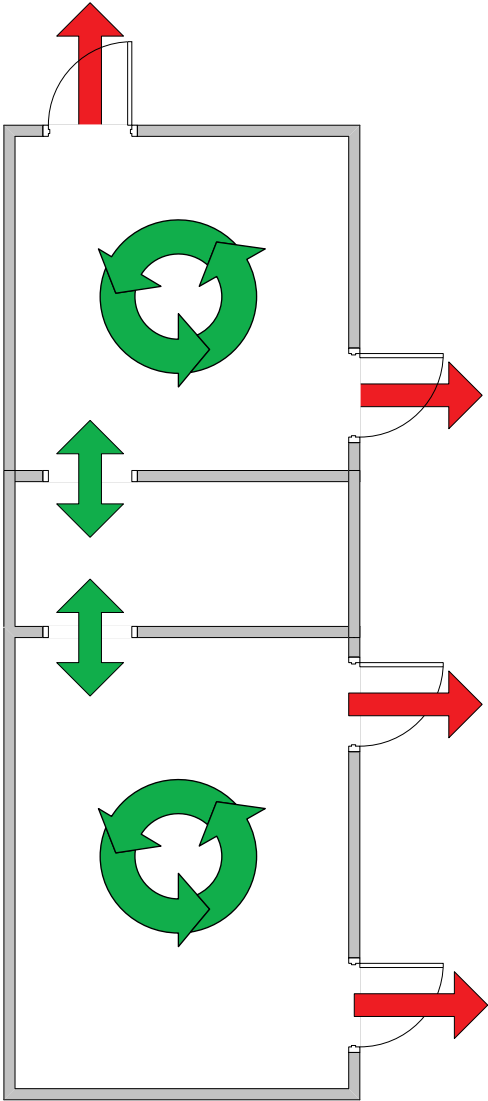

<b>Situation</b>	<b>Acceptable</b>	<b>Not Acceptable (rationale)</b>
Contiguous, connected labs, each with own PI	Waste is collected and retained within the confines of the lab space under the control of each PI.	Waste is transported and retained in a connected lab under the control of a different PI. (inability to maintain accountability of each generator)

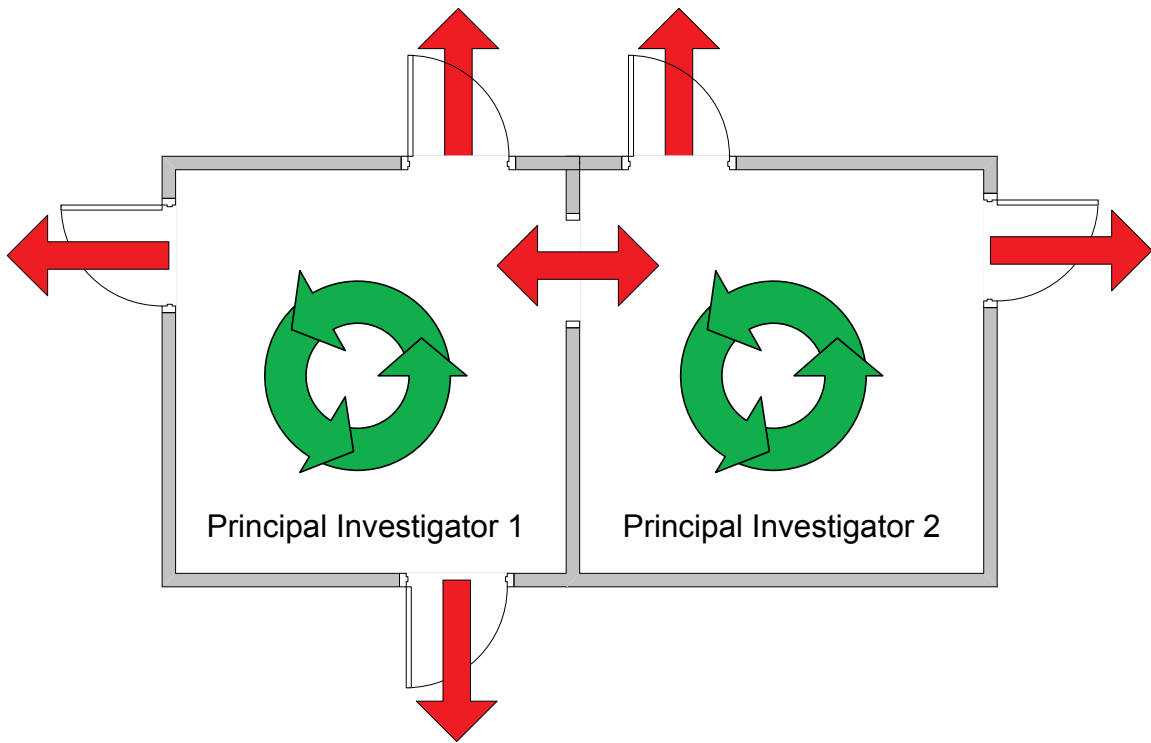

Situation	Acceptable	Not Acceptable (rationale)
Contiguous, connected labs, two PIs that run a joint lab	Waste is collected and retained within the confines of the lab space. PIs are considered co-operators.	Waste is transported across a public corridor to a location under the control of another PI. (personnel in lab space A cannot be held responsible for the management provided by those in lab space B; inability to maintain accountability of each generator)

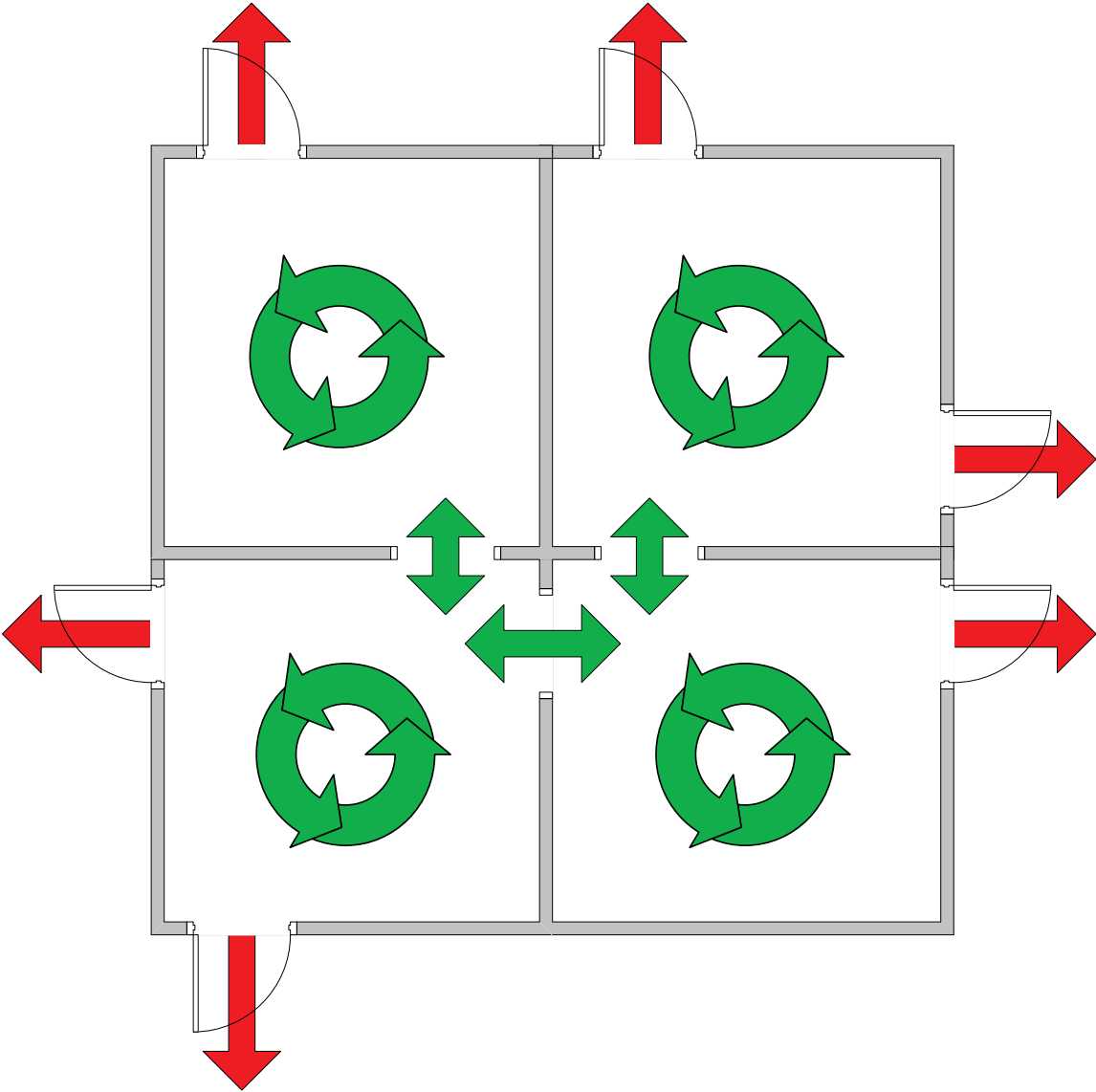

<b>Situation</b>	<b>Acceptable</b>	<b>Not Acceptable (rationale)</b>
Contiguous but not connected labs, single PI	Waste is collected and retained within the individual lab in which it is generated.	Waste is transported across a public corridor to another location under the control of the same or a different PI (regulation prohibits transfer of waste across/through public access corridor; personnel in lab space A cannot be held responsible for the management provided by those in Lab B; inability to maintain accountability of each generator)

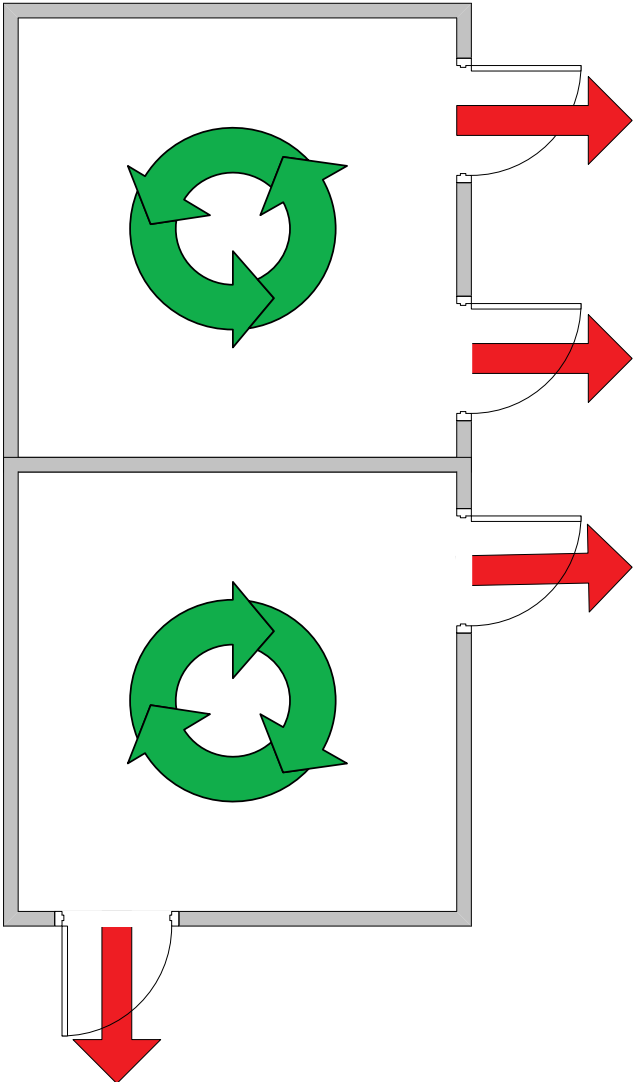



<b>Situation</b>	<b>Acceptable</b>	<b>Not Acceptable (rationale)</b>
Contiguous, connected labs with interstitial space, one PI	Waste is collected and retained within the confines of the lab space, and is not transferred across or retained in the interstitial space.	Waste is collected and retained at a location on either side of the interstitial space (inability to maintain accountability of each generator). Waste is transferred across the interstitial space (regulation prohibits transfer of waste across/through public access)

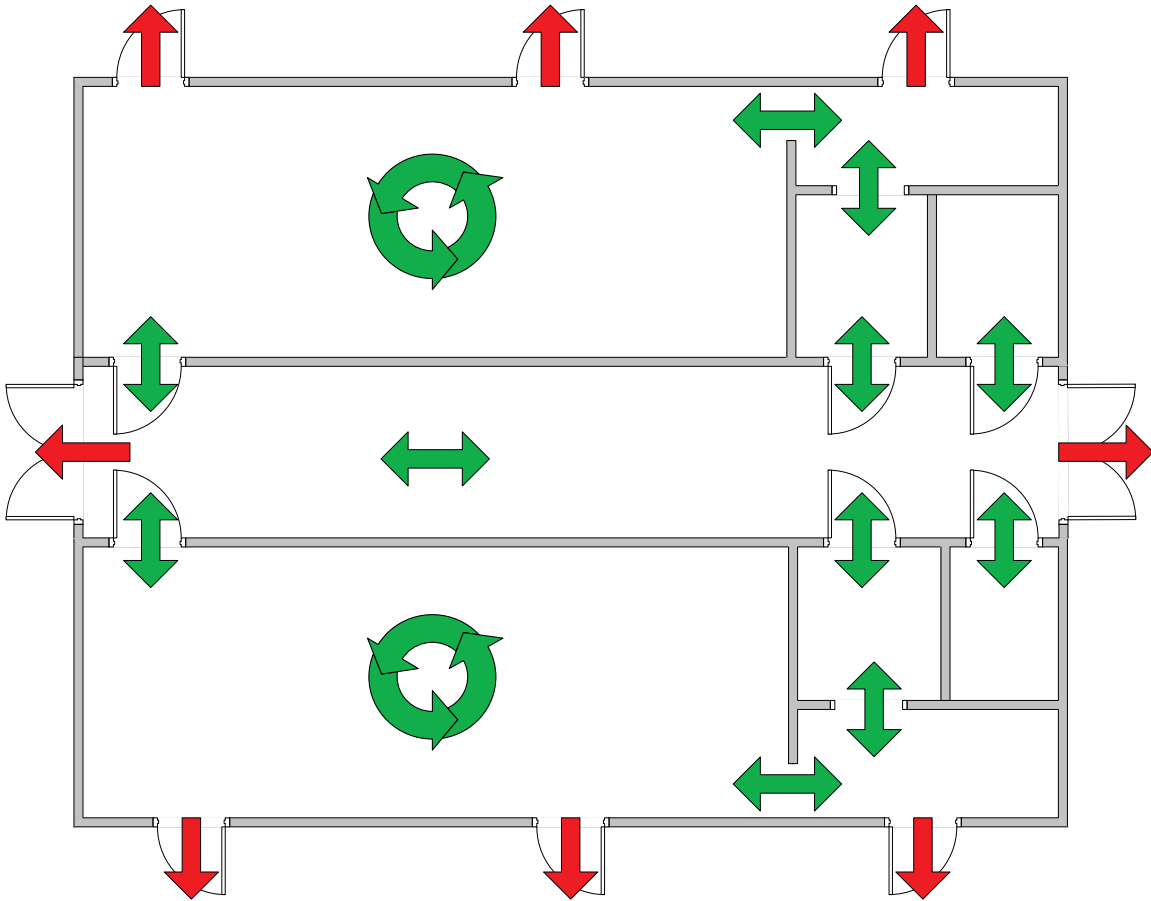

Situation	Acceptable	Not Acceptable (rationale)
Contiguous, connected labs with interstitial space, multiple PIs	Waste is collected and retained within the confines of the individual PI's lab.	Waste is transported and retained in a connected lab under the control of a different PI. (personnel in Lab A cannot be held responsible for the management provided by those in Lab B; inability to maintain accountability of each generator). Waste is transferred across the interstitial space (regulation prohibits transfer of waste across/through public access)

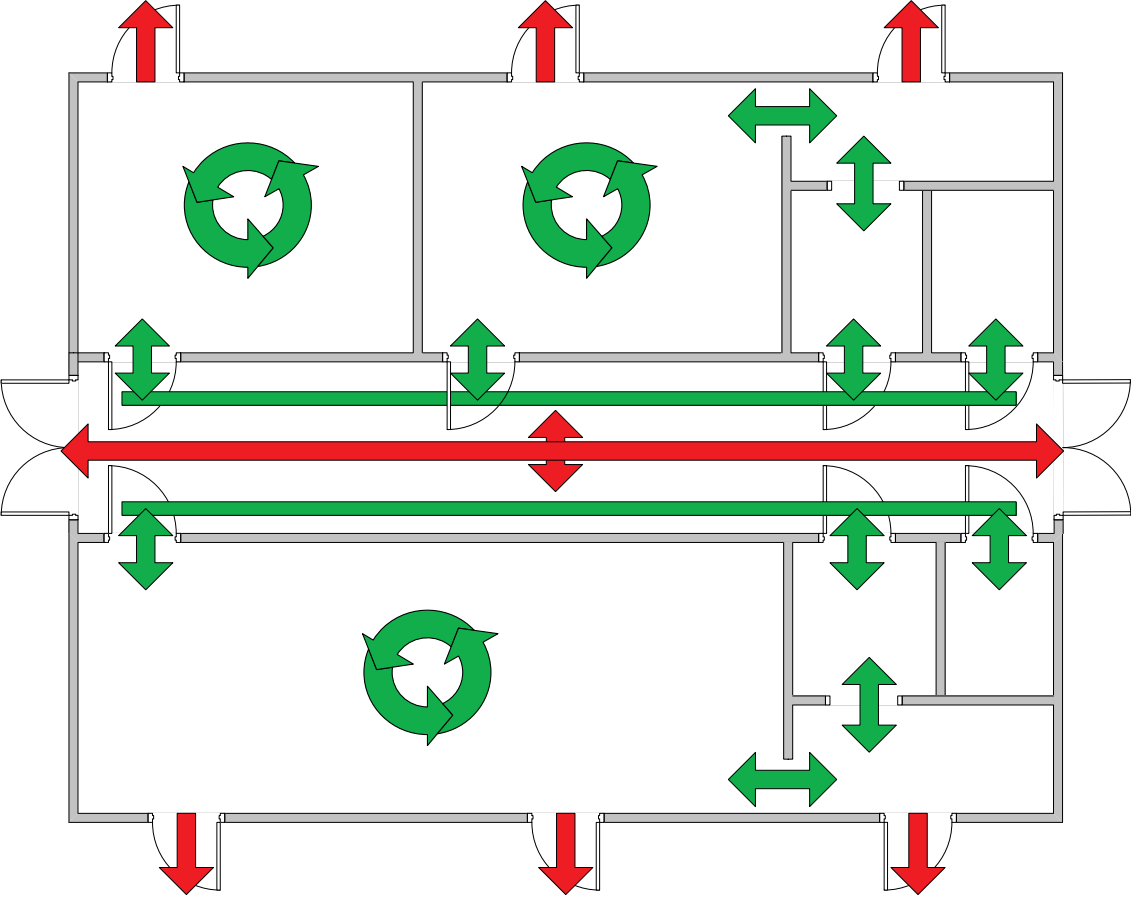

<b>Situation</b>	<b>Acceptable</b>	<b>Not Acceptable (rationale)</b>
Open lab, single PI	Waste is collected and retained at a consolidated location or at multiple locations within the lab	Waste is transferred from one location to another within the lab (regulations prohibits transfer of waste between accumulation areas)

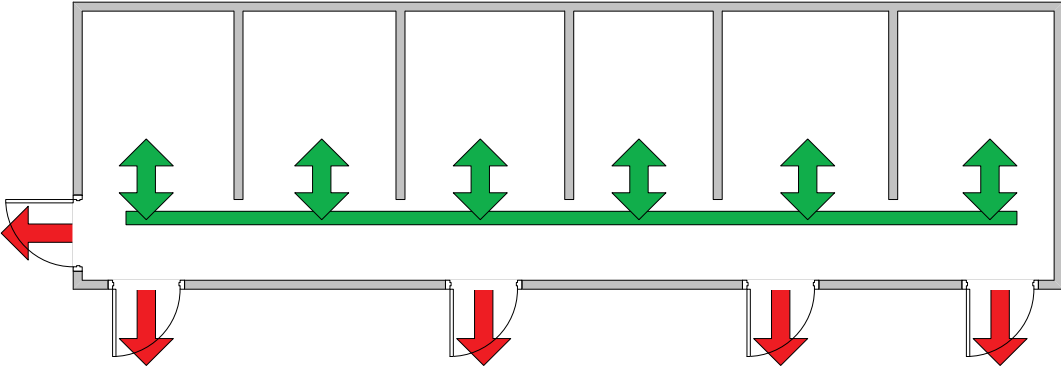

Situation	Acceptable	Not Acceptable (rationale)
Open lab, multiple PIs	Waste is collected and retained within the confines of the individual PI's area	Waste is collected and retained in a consolidated location within the lab (inability to maintain accountability of each generator)

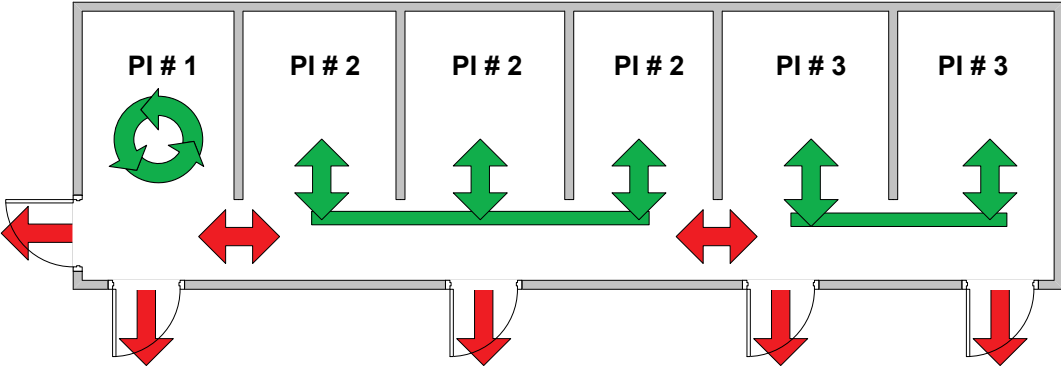

<b>Situation</b>	<b>Acceptable</b>	<b>Not Acceptable (rationale)</b>
Sub-divided, open lab	Waste is collected and retained within the confines of the lab space under the control of each PI. Waste is not maintained in areas with restricted access, rad materials or special equipment.	Waste is collected in a consolidated location within the lab (inability to maintain accountability of each generator).

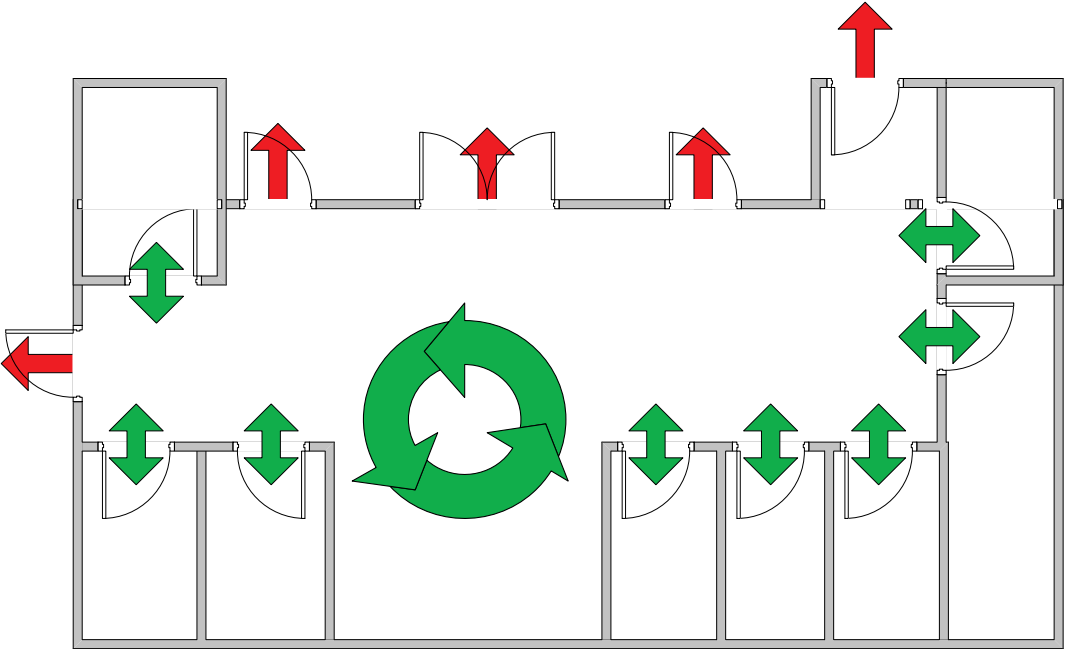

<b>Situation</b>	<b>Acceptable</b>	<b>Not Acceptable (rationale)</b>
Zone maintenance	Waste is collected in each work zone and is transferred to the Central Accumulation Facility before 55-gallons are reached, or the waste is transferred to the Central Accumulation Facility immediately upon generation.	Waste is stored at the generating location for more than 3 days after 55 gallons is accumulated. (regulations require transfer to the Central Accumulation Facility within 3 days when 55 gallons is reached).

<b>Situation</b>	<b>Acceptable</b>	<b>Not Acceptable (rationale)</b>
Common Use Space (Cold Rooms, Specialized Instrument Rooms, etc.)	Waste is collected in the space and after procedure is secured in a suitable container, labeled and transported by the most direct route to the generators primary work area.	Waste is left in the common use space (identification difficult/not under control of generator).